



aqaspas®

GAMA PROFESIONAL
Overflow spas | Spas con rebosadero

SPA HOTEL I



HOTEL I PORTABLE

Measurements Medidas	ø240 x 110 cm
Seats Asientos	6
Massage jets Jets de masaje	34
Air Jets Jets de aire	12
Inox. 316 structure Estructura inox. 316	Standard
SubLite Luz subacuática	Standard
ChromoLite Cromoterapia	Standard
Ozonator Ozonizador	Standard
Thermal cover Cubierta térmica	Standard
Titanium heater Calentador de titanio	3kW
Balboa® system Sistema Balboa®	TP600 + AX40
Massage pumps Bombas de masaje	2 x 2HP/CV 1.5kW
Air pump Bomba de aire	400W
Circulation pump Bomba de circulación	0.35kW
Compensation tank	Incorporated
Water volume Volumen de agua	1600 l.
Dry weight	420kg
Filtration system with high density pressure filter or (optional) sand filter Sistema de filtración con con filtro de alta densidad a presión o (opcional) filtro de arena.	

OPTIONS | OPCIONES

Fusion Stereo I
Balboa® WiFi
Heat pump Bomba de calor 0.64kW input/3.45kW output
Automatic drainage Drenaje automático



HOTEL I IN GROUND

Measurements Medidas	ø240 x 110 cm
Seats Asientos	6
Massage jets Jets de masaje	34
Air Jets Jets de aire	12
Inox. 316 structure Estructura inox. 316	Standard
SubLite Luz subacuática	Standard
ChromoLite Cromoterapia	Standard
Ozonator Ozonizador	Standard
Thermal cover Cubierta térmica	Standard

EQUIPMENT MODULE | MÓDULO CON EQUIPAMIENTO

Titanium heater Calentador de titanio	3kW
Balboa® system Sistema Balboa®	TP600 + AX40
Massage pumps Bombas de masaje	2 x 2HP/CV 1.5kW
Air pump Bomba de aire	400W
Circulation pump Bomba de circulación	0.35kW
Filtration system	Sand Arena

OPTIONS | OPCIONES

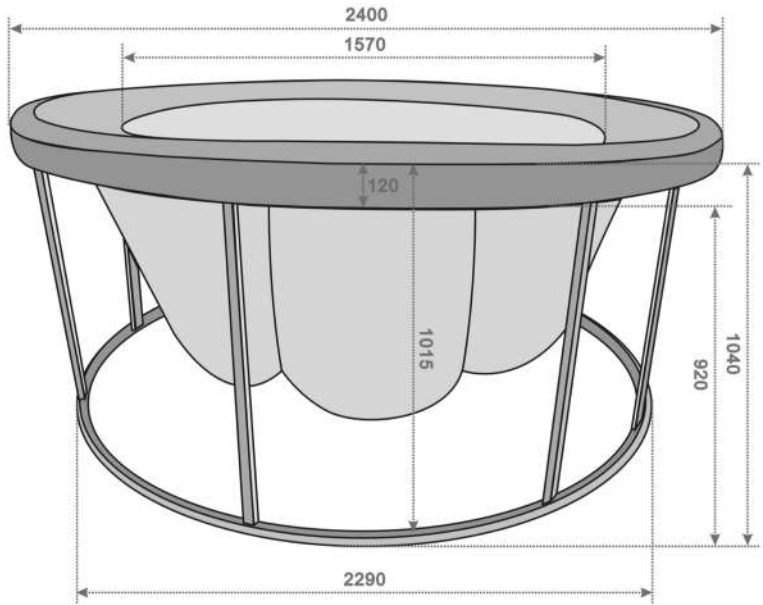
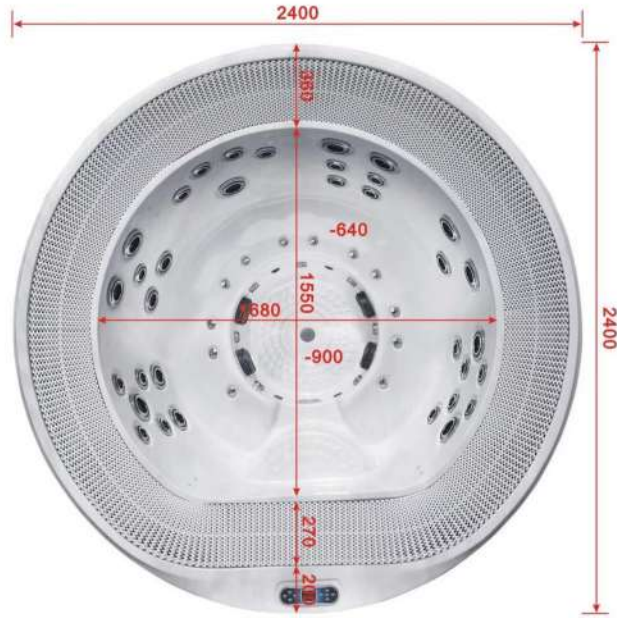

Tanque de compensación Compensation tank
Caja eléctrica Electrical box
Balboa® WiFi
Heat pump Bomba de calor 0.64kW input/3.45kW output
Equipamiento de regulador de Cl & pH Cl & pH Feeder
Automatic drainage Drenaje automático

MEASUREMENTS | MEDIDAS



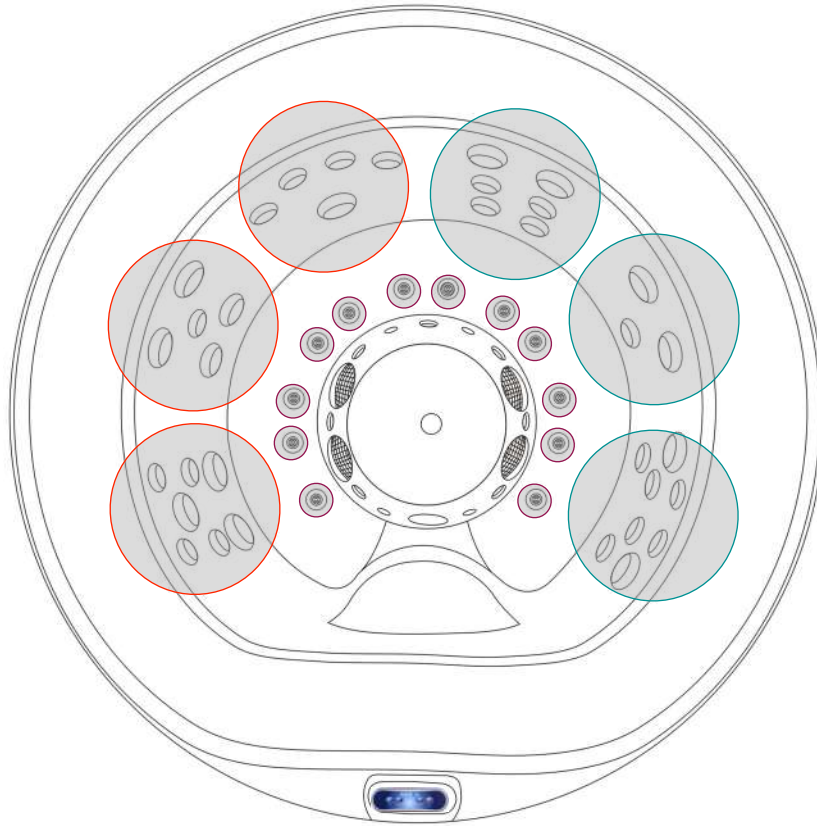



Water & AIR | Agua & Aire



-  Massage pump 1 | Bomba de masaje 1
-  Massage pump 2 | Bomba de masaje 2
-  Air jets | Jets de aire



-  Lights | Luces
-  Air | Aire
-  Pump 2 | Bomba 2
-  Pump 1 | Bomba 1

Chromotherapy | Cromoterapia

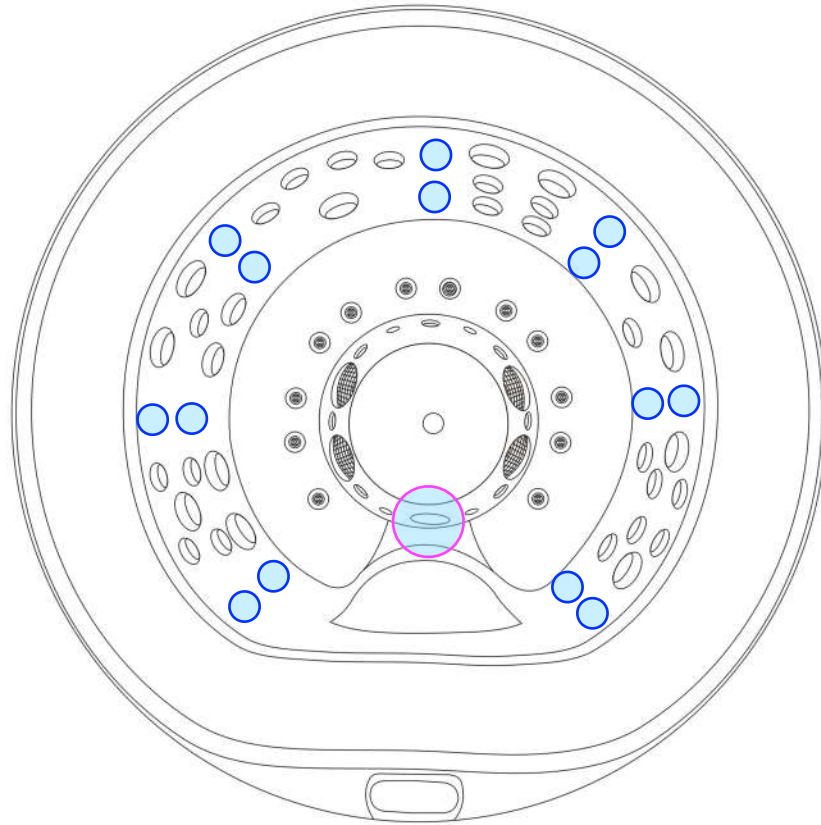

● LEDs x 14

● SubLite x 1

COMPONENTS | COMPONENTES (Portable)

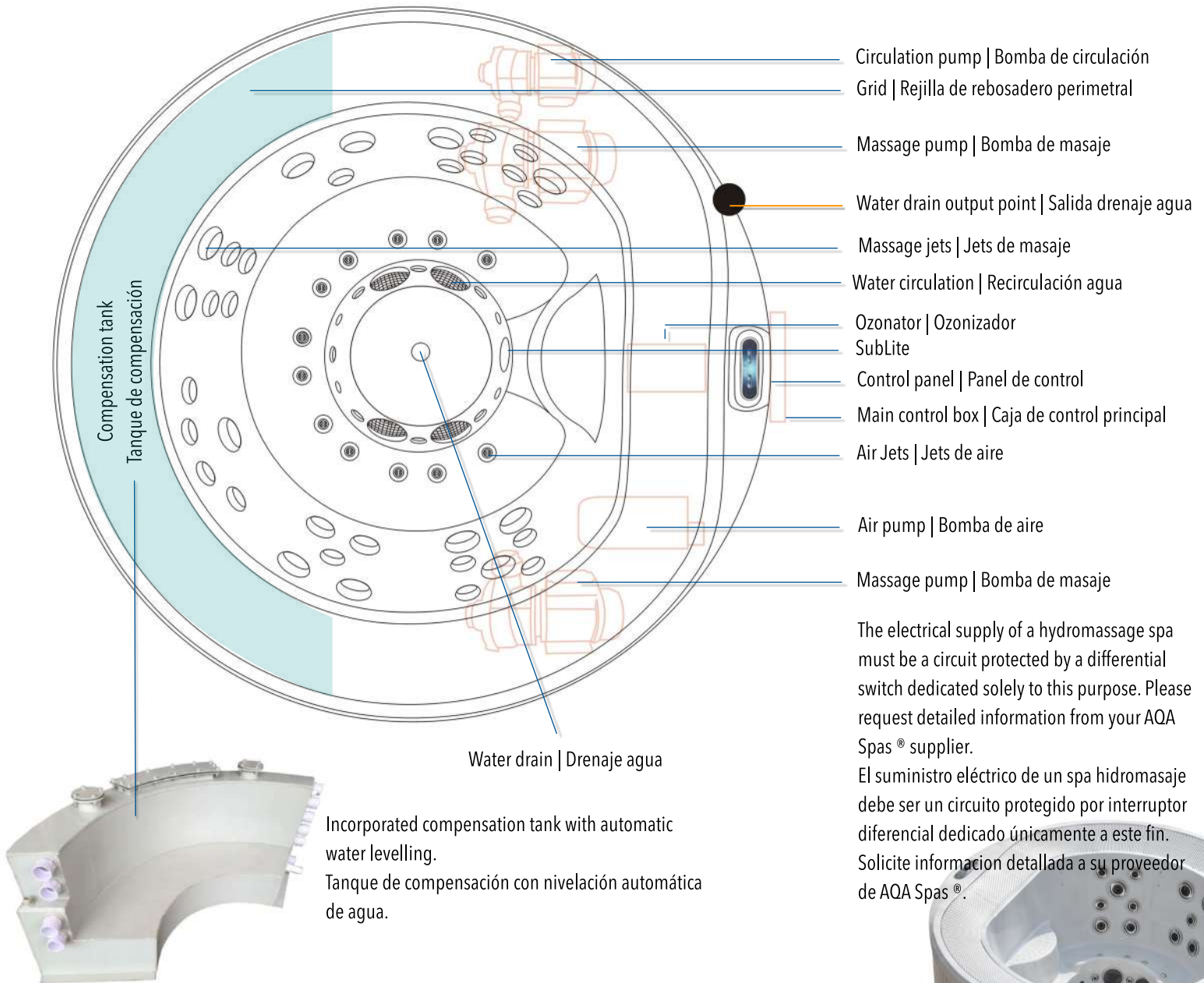

- Circulation pump | Bomba de circulación
- Grid | Rejilla de rebosadero perimetral
- Massage pump | Bomba de masaje
- Water drain output point | Salida drenaje agua
- Massage jets | Jets de masaje
- Water circulation | Recirculación agua
- Ozonator | Ozonizador
- SubLite
- Control panel | Panel de control
- Main control box | Caja de control principal
- Air Jets | Jets de aire
- Air pump | Bomba de aire
- Massage pump | Bomba de masaje

The electrical supply of a hydromassage spa must be a circuit protected by a differential switch dedicated solely to this purpose. Please request detailed information from your AQA Spas® supplier.

El suministro eléctrico de un spa hidromasaje debe ser un circuito protegido por interruptor diferencial dedicado únicamente a este fin. Solicite información detallada a su proveedor de AQA Spas®.

Incorporated compensation tank with automatic water levelling.
Tanque de compensación con nivelación automática de agua.



MODULE | MÓDULO (Hotel I In Ground)

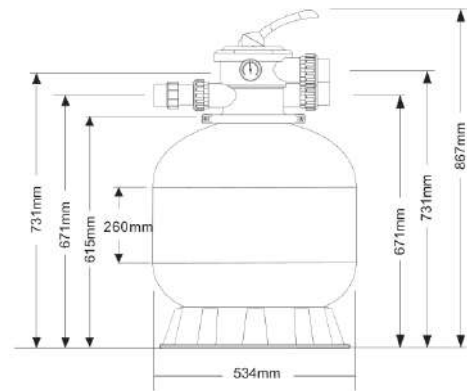
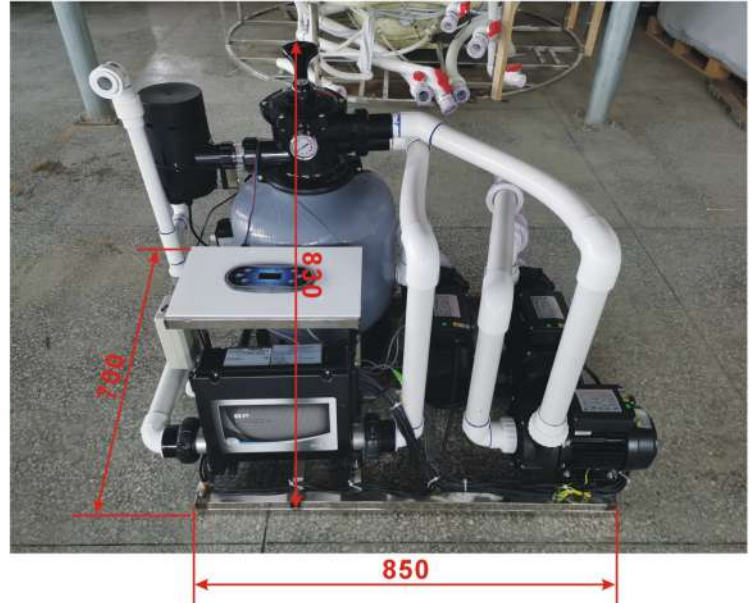
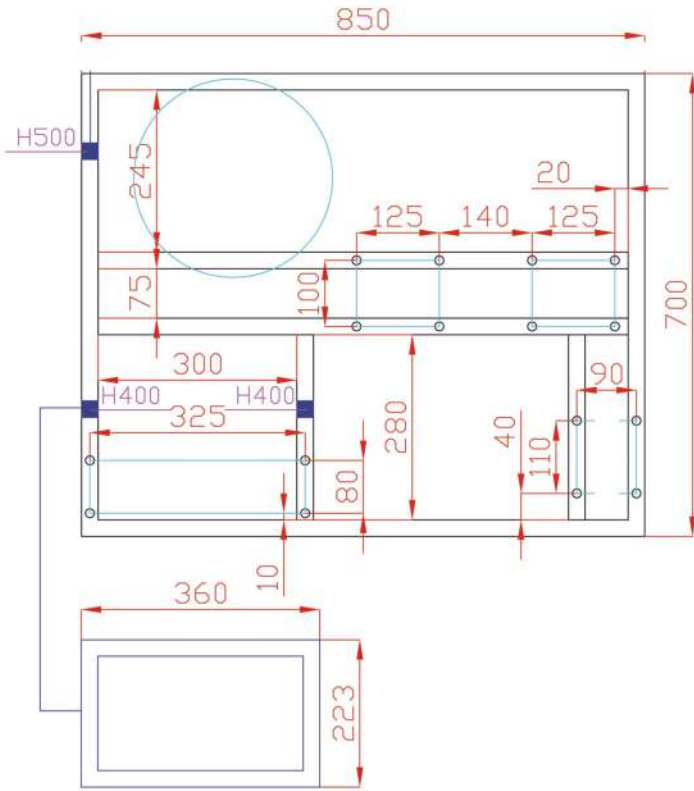

WATERCARE

CRYSTAL CLEAN AND CLEAR WATER

All our spas and swimspas are equipped with an ozonator. We always supply water maintenance instructions with your spa, where we recommend the use of additional water care products. For spas for public use, **we recommend the installation of an automatic cl/pH feeding system.**

OZONATOR

An ozonator injects ozone (O₃) to the tubery system of the spa, it disinfects the water, and quickly turns into normal oxygen. A 100% natural way to clean the water of your spa which additionally removes oils and lotions.

AGUA CRISTALINA Y LIMPIA

Todos nuestros spas y swimspas están equipados con un ozonizador. Siempre suministramos instrucciones de mantenimiento de agua con su spa, donde recomendamos el uso de productos adicionales para el cuidado del agua. **Para spas de uso público, recomendamos la instalación de un sistema automático de alimentación de Cl/pH.**

OZONIZADOR

Un ozonizador inyecta ozono (O₃) al sistema de tuberías del spa, desinfecta el agua y se convierte rápidamente en oxígeno normal. Una forma 100% natural de limpiar el agua de su spa que además elimina aceites y lociones.







A DIFFERENT MASSAGE IN EACH SEAT | UN MASAJE DIFERENTE EN CADA ASIENTO



COLOURS

PANELS PanPlus



Woven Espresso



Dark Woven Grey



Black

COVER CoverChoice



Brown



Espresso



Light Grey



Dark Grey



Woven Grey



White



Pure White



Gypsum



White Silver Marble



aqaspas[®]
www.aqaspas.com

OUR TEAM AT AQA SPAS IS INTERNATIONAL. WE SPEAK ENGLISH. WIJ SPREKEN NEDERLANDS.
WIR SPRECHEN DEUTSCH. VI PRATAR SVENSKA. ON PARLE FRANÇAIS. МЫ ГОВОРИМ ЛО-РУССКИ.

®

Specifications in this catalogue may be subject to change. © aqa spas[®] 2020. aqa spas is a registered trade mark.